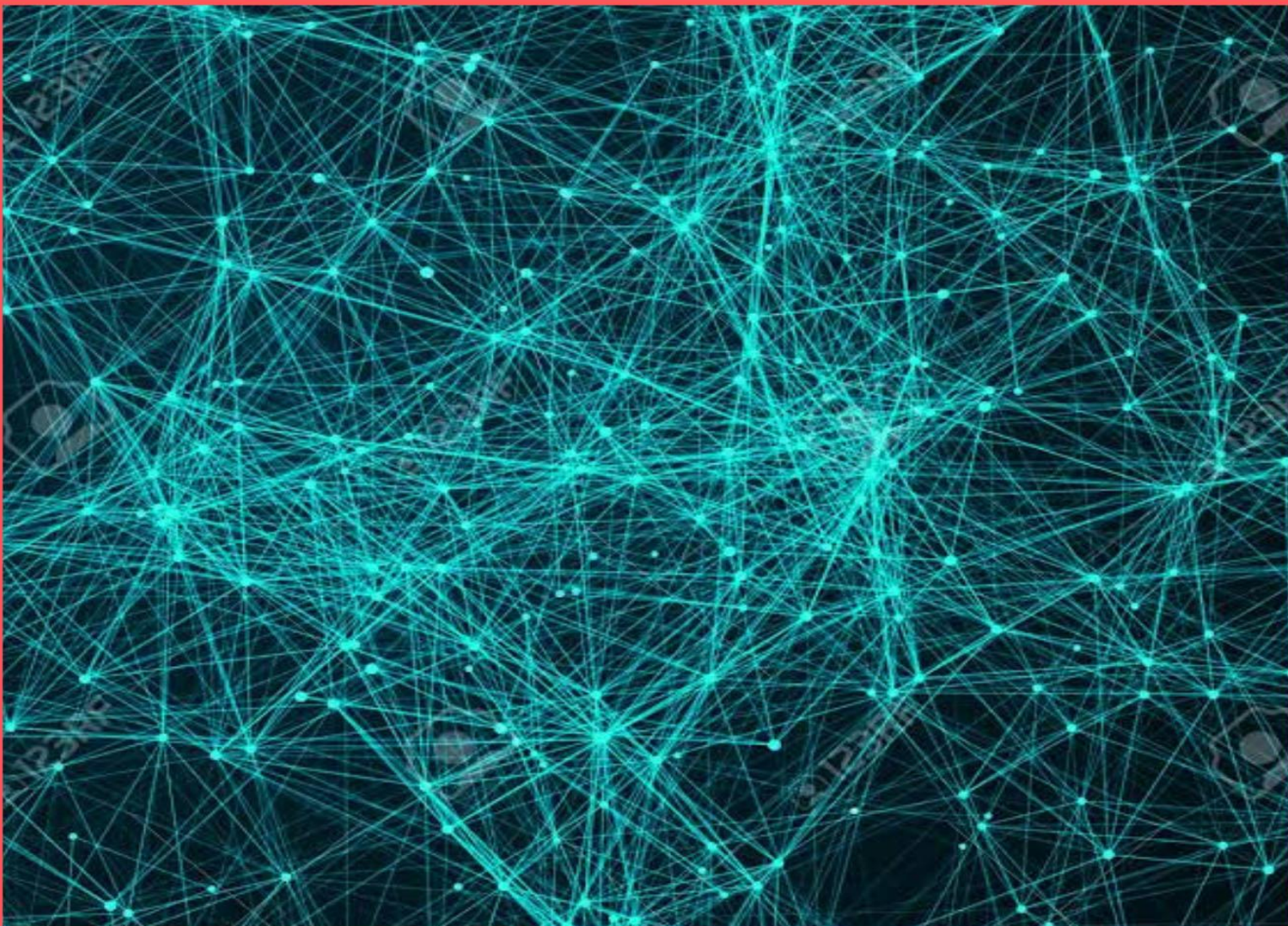


# Journal of Engineering Sciences

*( An open access peer reviewed Journal )*



**SIR PUBLISHERS**  
**[www.sirpublishers.com](http://www.sirpublishers.com)**

ARTICLES:

DATA LOGGER ANALYSIS FOR WIRELESS COMMUNICATION USING ZIGBEE (802.15.4) APPLICATIONS <b>Sanjay Singh, Anurag Chandana</b>	<b>3</b>
ANEMIA AND RELATED NUTRIENT DEFICIENCIES AFTER ROUX-EN-Y GASTRIC BYPASS SURGERY: A SYSTEMATIC REVIEW AND META-ANALYSIS <b>Ting-Chia Weng</b>	<b>14</b>
PERCEIVED USEFULNESS OF DESIGN THINKING ACTIVITIES FOR TRANSFORMING RESEARCH TO IMPACT FOR FOOD SAFETY RESEARCH <b>Nina Veflen, Antje Gonera</b>	<b>18</b>
THE TAX LEARNING AND TAX COMPLIANCE BEHAVIOUR IN MOGADISHU, SOMALIA <b>Amani Abou Zaid</b>	<b>22</b>
INVESTIGATION OF RICE HUSK ASH CEMENTITIOUS CONSTITUENT IN CONCRETE <b>Oyejobi, Damilola Oyewumi , Abdulkadir, Taofeeq Sholagberu, Ajibola, Victor Motolani</b>	<b>26</b>
HEMŞİRELERİN PROFESYONEL DEĞERLERİ VE ETKİLEYEN FAKTÖRLER <b>Tuğbağ Subaşı, Gamze Özbek Güven</b>	<b>30</b>

## DATA LOGGER ANALYSIS FOR WIRELESS COMMUNICATION USING ZIGBEE (802.15.4) APPLICATIONS

Sanjay Singh<sup>\*1</sup> & Anurag Chandana<sup>2</sup>

<sup>\*1</sup>M. Tech Scholar, Dept. of ECE, RCE, Roorkee, India

<sup>2</sup>Assistant Professor, Dept. of ECE, RCE, Roorkee, India

---

### ABSTRACT

*This dissertation is to produce data logger for remote system. It consists of a temperature sensor for constantly monitoring temperature and Zigbee module for wireless data transfer at short distances. The measured temperature parameter will be sent to microcontroller system. And with the help of Zigbee module temperature is sent to computer from remote area on digital displays. In recent time is sent with the help of inbuilt RTC which ARM7 (LPC2148) microcontroller system has got. There will also provision for setting of RTC time if user required in any case and it is done with the help of remote computer. When microcontroller circuit power up then user is ask to set RTC time after this data transfer take place continuously which appears on computer via Zigbee module connected to computer.*

**KEYWORDS:** Zigbee, microcontroller, monitoring Temp.

---

### INTRODUCTION

The original model for this system consists of standalone data logger. As the requests from users are getting higher, the application of wireless communication as medium transmission rather than the use of wires. Other than that, extra features or some kind of bonus will be add to this system which is capable to access to wireless communication for alarming some events. Moreover, these systems which apply low power consumption are easy to manage and install. It is based on wireless sensor networks.

Wireless Sensor Network consists of large numbers of sensor nodes. The nodes are equipped with sensor devices that are used for a certain applications. For example, the sensor device is camera and it is used to retrieve the environment data visually, microphone is used to detect the sound, thermometer and thermocouple are used to detect the changes in temperature. Every sensor nodes are also equipped with wireless module in order to communicate with each other. The communication between the nodes are performed by establishing the routing topology in the system before the data can be transmit from the certain sensor node to the collection point or host

Wireless sensor network (WSN) is an emerging technology and has great potential to be employed in critical situations. Wireless sensor networks have been deployed in various monitoring applications such as industrial, health, environmental, and security The Wireless Sensor Networks comprise of relatively inexpensive sensor nodes capable of collecting, processing, storing and transferring

information from one node to another. These nodes are able to autonomously form a network through which sensor readings can be propagated [20].

Therefore, a standard is required that is capable of establishing the network between these nodes as well as provide low cost and less power consumption. Fortunately, there is a standard called ZigBee that is capable of accomplishing all these requirements.

ZigBee standard is developed by the ZigBee Alliance that defines the communication protocols for low-data-rate and short-range wireless networking. ZigBee based wireless devices operate at 868 MHz, 915 MHz, and 2.4 GHz frequency bands. ZigBee is developed on the top of IEEE 802.15.4 standard . is designed for low-power consumption and allows batteries to last up to years using primary cells without any chargers (low cost and easy

installation). ZigBee has a wide application area such as home networking, industrial networking, system monitoring and many more having different profiles specified for each field.

## 1. MATERIALS AND METHODS

### ADC working

Most real world data is in analog form. Whether it be temperature, pressure, voltage, etc, their variation is always analog in nature..so we have to convert this analog data into digital format so that computer or microcontroller can understand it and process on it. Sensor gives analog data in form of variation in current and voltage, ADC read this variation and process a digital data according to analog input and send to microcontroller to process it further.

### Terms used in ADC

Resolution – The resolution of the converter indicates the number of discrete values it can produce over the range of analog values. A computer is a digital machine that stores a number in binary. If you are storing a digital 2-bit number you can store 4 different values: 00, 01, 10, or 11. Now, you can say ADC have 2-bit resolution and you have a device which converts an analog voltage between 0 and 10 volts into a 2-bit digital value for storage in a computer.

This device will give digital values as follows

**Table 1.0**

Voltage	2-Bit Digital Representation
0 to 2.5	00
2.5 to 5	01

5 to 7.5	10
7.5 to 10	11

Note:

- Higher the resolution smaller the step size
- Smaller the step size better accuracy

Step size – small amount of change in analog input that can understand

for example 8-bit ADC,

$$\text{step size} = V_{\text{ref}} / 2^8 - 1 = V_{\text{ref}} / 255$$

$V_{\text{ref}}$  – used to detect step size

Conversion –

$$D_{\text{out}} = V_{\text{input}} / (\text{step size})$$

$D_{\text{out}}$  – decimal output digital data

$V_{\text{input}}$  – analog input voltage

For example – for 8 bit ADC,  $V_{\text{ref}} = 2.56 \text{ V}$ , calculate digital output for 1.7 V input.

$$\text{step size} = (2.56 \text{ V}) / 256 = 10 \text{ mV}$$

$$D_{\text{out}} = (1.7 \text{ V}) / (10 \text{ mV}) = 170 = 10101010$$

### Method to inbuilt ADC

In this tutorial we will go through LPC2148 adc programming. Analog to Digital Conversion (i.e. ADC), as the name suggests, is all about converting a given analog signal into its digital form or say a digital value. So, what does this mean? Well, basically its measuring the voltage of a given analog signal. The analog signal can be differential, single-ended unipolar, etc. The converted digital value represents the measured voltage. This conversion or measurement happens in presence of a fixed and accurate reference voltage. The analog signal is compared to this reference voltage and then estimations are made to get the final measured value.

### ADC on LPC214x

ADC on LPC214x is based on Successive Approximation (SAR) conversion technique.

### Pins relating to ADC Module of LPC214x:

**Table 2.0**

Pin	Description
AD0.1 to AD0.4 (P0.28/29/30/25) and AD0.6, AD0.7 (P0.4/5)	Analog input pins. <b>Note from Datasheet:</b> "If ADC is used, signal levels on analog input pins must not be above the level of $V_{\text{dda}}$ at any time. Otherwise, A/D

	converter readings will be invalid. If the A/D converter is not used in an application then the pins associated with A/D inputs can be used as 5V tolerant digital IO pins.”
Vref	This is the reference voltage pin. It must be connected to an accurate reference voltage source.
Vdda,Vssa	Vdda is Analog Power pin and Vssa is Ground pin used to power the ADC module.

Registers used for ADC programming in LPC214x

**(For AD1 registers replace 0 with 1 wherever applicable)**

1) AD0CR – A/D Control Register : This is the main control register for AD0

1. Bits[7 to 0] – SEL : This group of bits are used to select the pins(Channels) which will be used for sampling and conversion. Bit ‘x’(in this group) is used to select pin A0.x in case of AD0.
2. Bits[15 to 8] – CLKDIV : These bits stores the value for CLKDIV which is used to generate the ADC clock. Peripheral clock i.e. PCLK is divided by CLKDIV+1 to get the ADC clock
3. Bit 16 – BURST : Set this to 1 for doing repeated conversions. Set this bit to 0 for software controlled conversions , which take 11 clocks to finish.
4. Bits[19 to 17] – CLKS : These bits are used to select the number of clocks used for conversion in burst mode along with number of bits of accuracy of the result in RESULT bits of ADDR.

**Table 3.0**

Value	clocks / bits
000	11 clocks / 10 bits
001	10 clock / 9 bits
010	9 clock / 8 bits
011	8 clock / 7 bits
100	7 clock / 6 bits
101	6 clock / 5 bits
110	5 clock / 4 bits
111	4 clock / 3 bits

5. Bit 21 – PDN : Set it to 1 for powering up the ADC and making it operational. Set it to 0 for bringing it in power down mode.

6. Bits[26 to 24] – START : These bits are used to control the start of ADC conversion when BURST (bit 16) is set to 0. Below is the table as given in datasheet :

**Table 4.0**

Value	Significance
000	No start (this value is to be used when clearing PDN to 0)
001	Start the conversion
010	Start conversion when the edge selected by bit 27 occurs on P0.16/EINT0/MAT0.2/CAPO.2 pin
011	Similar to above – for MAT0.0 pin
100	Similar to above – for MAT0.1 pin
101	Similar to above – for MAT0.3 pin
110	Similar to above – for MAT1.0 pin
111	Similar to above – for MAT1.1 pin

7. **Bit 27 – EDGE** : Set this bit to 1 to start the conversion on falling edge of the selected CAP/MAT signal and set this bit to 0 to start the conversion on rising edge of the selected signal. (Note: This bit is of used only in the case when the START contains a value between 010 to 111 as shown above.)

8. Other bits are reserved.

**AD0GDR – A/D Global Data Register:** This is the global data register for the corresponding ADC module. It contains the ADC's DONE bit and the result of the most recent A/D conversion.

1. Setting up and configuring ADC Module for software controlled mode :

*First we will define some values which will help us setup the ADOCR register to configure the ADO block before we can use it.*

```
#define CLKDIV (15-1) // 4Mhz ADC clock (ADC_CLOCK=PCLK/CLKDIV) where "CLKDIV-1" is actually
used , in our case PCLK=60mhz
#define BURST_MODE_OFF (0<<16) // 1 for on and 0 for off
#define PowerUP (1<<21) //setting it to 0 will power it down
#define START_NOW ((0<<26)|(0<<25)|(1<<24)) //001 for starting the conversion immediately
#define ADC_DONE (1<<31)
```

*Here we define CLKDIV which is divided by PCLK to get the ADC clock <=4Mhz. In our case we will be using a PCLK of 60Mhz hence we divide 60Mhz by 15 to get 4Mhz. But note that the ADC module actually needs a value of (CLKDIV-1). This is because it adds "+1" to the value internally (in case if user*

uses a CLKDIV of 0 it will be still valid). For our purposes CLKDIV is a 'zero-indexed' value hence we must subtract it by 1 before using it. In our case we need to supply a value of 14 i.e. (15-1) to ADOCR.

BURST\_MODE\_OFF(bit 16) , PowerUP(bit 21) and ADC\_DONE(bit 31) are defined as required. CLKS\_10bit has been defined for 10 bit resolution - you can change the bit combination as per your needs. Finally START\_NOW is defined as "001" which is for starting the conversion 'now'.

Next we define ADOCR\_setup which contains basic configuration for setting up the ADC Module. We feed CLKDIV, BURST\_MODE\_OFF and PowerUP into ADOCR\_setup as follows  
unsigned long ADOCR\_setup = (CLKDIV<<8) | BURST\_MODE\_OFF | PowerUP;

Now we assign ADOCR\_setup to ADOCR along with channel selection information to select channels as required. Finally we assign(by ORing) START\_NOW to ADOCR to start the conversion process as shown :

```
ADOCR = ADOCR_setup | SEL_AD06;  
ADOCR |= START_NOW;
```

Note that ADOCR can be assigned/setup in a single step. But I am doing it in three steps to keep things simpler.

## 2. Setting up and configuring ADC Module for Burst mode :

Configuring ADC Module is similar to what was done in software controlled mode except here we use the CLKS bits and don't use the START bits in ADOCR. ADC\_DONE is also not applicable since we are using an ISR which gets triggered when a conversion completes on any of the enabled channels.

```
#define CLKDIV (15-1) // 4Mhz ADC clock (ADC_CLOCK=PCLK/CLKDIV) where  
"CLKDIV-1" is actually used , in our case PCLK=60mhz  
#define BURST_MODE_ON (1<<16) // 1 for on and 0 for off  
#define CLKS_10bit ((0<<19)|(0<<18)|(0<<17)) //10 bit resolution  
#define PowerUP (1<<21) //setting it to 0 will power it down
```

## 3. Fetching the conversion result in software controlled mode :

In software controlled mode we continuously monitor bit 31 in the corresponding channel data register ADDR. If bit 31 changes to 1 from 0 , it means that current conversion has been completed and the result is ready. For example , if we have used channel 6 of AD0 then we monitor for changes in bit 31 as follows :

```
while( (AD0DR6 & ADC_DONE) == 0 ); //this loop will terminate when bit 31 of AD0DR6
```

## 4. Fetching the conversion result in Burst mode :



In Burst mode we use an ISR which triggers at the completion of a conversion in any one of the channel. Now , we just need to find the Channel for which the conversion was done. For this we fetch the channel number from AD0GDR which also stores the conversion result. Bits 24 to 26 in AD0GDR contain the channel number. Hence , we shift it 24 places and use a 3bit mask value of 0xF as shown below :

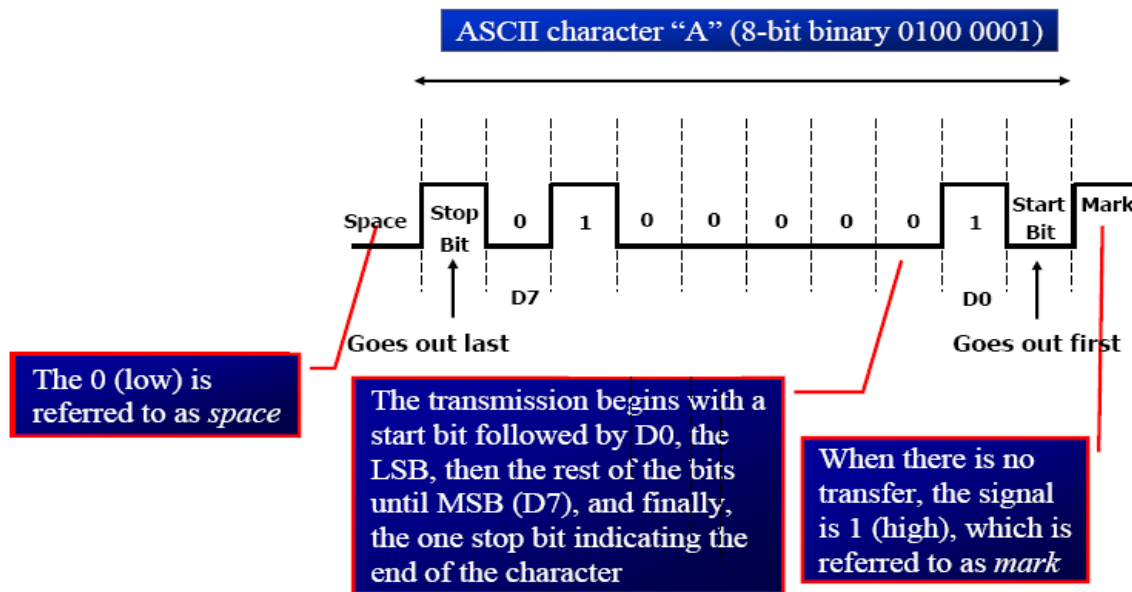
```
unsigned long AD0GDR_Read = AD0GDR;
int channel = (AD0GDR_Read>>24) & 0xF; //Extract Channel Number
```

After knowing the Channel number, we have 2 options to fetch the conversion result from. Either we can fetch it from AD0GDR or from AD0DRx of the corresponding channel. In the examples covered in 'examples section' of this tutorial I have used AD0GDR for extracting the conversion result as follows :

```
int currentResult = (AD0GDR_Read>>6) & 0x3FF; //Extract Conversion Result
```

**Introduction of inbuilt UART**

Here is a quick recap of UART basics : Uart uses TxD(Transmit) Pin for sending Data and RxD(Receive) Pin to get data. UART sends & receives data in form of chunks or packets. These chunks or packets are also referred to as 'transmission characters'. The structure of a UART data packet is as shown below :



**Figure 1.0**

Now , Lets start with the main Tutorial. LPC214x has 2 UART blocks which are UART0 and UART1. For UART0 the TxD pin is P0.0 and RxD pin is P0.1 and similarly for UART 1 the TxD pin is P0.8 and RxD pin is P0.9 as shown in the table below :

**Table 5.0**

Pins:	TxD	RxD
UART0	P0.0	P0.1
UART1	P0.8	P0.9

### **Registers used for UART programming in LPC214x:**

Before we can use these pins to transfer data , first we need to configure and initialize the UART block in our LPC214x microcontroller. But before doing that, lets go through some of the important registers: (for UART1 registers replace 0 with 1)

#### **Data Related Registers :**

- 1) UORBR – Receiver Buffer Register (READ ONLY!): This register contains the top most byte(8-bit data chunk) in the Rx FIFO i.e the oldest received data in FIFO. To properly read data from UORBR , the DLAB(Divisor Latch Access) bit in UOLCR register must be first set to 0.
- 2) UOTHR – Transmit Holding Register (WRITE ONLY!): UOTHR contains the top most byte in Tx FIFO and in this case its the newest(latest) transmitted data. As in the case with UORBR , we must set DLAB=0 to access UOTHR for write operation.

#### **Baud Rate Setup related registers :**

**1) UODLL and UODLM – Divisor Latch registers:** Both of them hold 8-bit values. These register together form a 16-bit divisor value which is used in baud rate generation which we will see in later section. UODLM holds the upper 8-bits and UODLL holds the lower 8-bits and the formation is “[UODLM:UODLL]”. Since these form a divisor value and division by zero is invalid, the starting value for UODLL is 0x01 (and not 0x00) i.e the starting value in combined formation is “[0x00:0x01]” i.e 0x0001. Please keep this in mind while doing baud-rate calculations. In order to access and use these registers properly, DLAB bit in UOLCR must be first set to 1.

**2) UOFDR – Fractional Divider Register :** This register is used to set the prescale value for baud rate generation. The input clock is the peripheral clock and output is the desired clock defined by this register. This register actually holds to different 4-bit values (a divisor and a multiplier) for prescaling which are:

1. **Bit [3 to 0] – DIVADDVAL :** This is the prescale divisor value. If this value is 0 then fractional baud rate generator wont have any effect on Uart Baud rate.
2. **Bit [7 to 4] – MULVAL :** This is prescale multiplier value. Even if fractional baud rate generator is not used the value in this register must be more than or equal to 1 else UART0 will not operate properly.
3. Other Bits reserved.

*Remark from Usermanual :* “If the fractional divider is active (DIVADDVAL > 0) and DLM = 0, the value of the DLL register must be 2 or greater!”

### UART Baud Rate Generation:

In most cases the actual baudrate will drift a little above or below the desired baud and also, as the desired baudrate increases this drift or error will also increase – this is because of the equation itself and the limitations on MULVAL , DIVADDVAL! For e.g. if the desired baud rate is 9600 and you get a baud like 9590 , 9610 , 9685 , 9615 , etc.. then in almost all cases it will work as required. In short , a small amount of error in actual baudrate is generally tolerable in most systems.

The master formula for calculating baud rate is given as :

$$\text{BaudRate} = \frac{\text{PCLK in Hertz}}{16 \times (256 \times \text{DLM} + \text{DLL}) \times (1 + \text{DIVADDVAL}/\text{MULVAL})}$$

which can be further simplified to :

$$\text{BaudRate} = \frac{\text{PCLK in Hertz}}{16 \times (256 \times \text{DLM} + \text{DLL})} \times \frac{\text{MULVAL}}{\text{MULVAL} + \text{DIVADDVAL}}$$

with following conditions strictly applied :

$$0 < \text{MULVAL} \leq 15$$

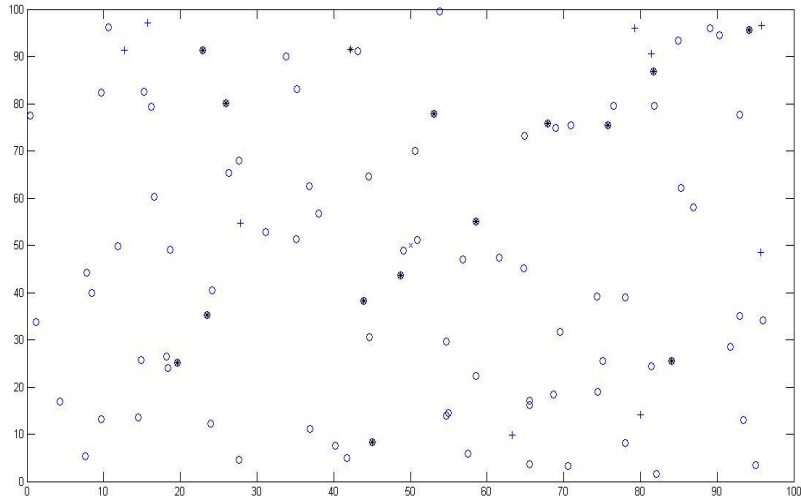
$$0 \leq \text{DIVADDVAL} \leq 15$$

If DIVADDVAL > 0 & DLM = 0 then, DLL >= 2

As it can be seen this formula has 2 prominent parts which are : A Base value and a Fractional Multiplier i.e: BaudRate = [ Base ] x [ Fraction(i.e. Prescale) ]. This Fractional Multiplier can be used to scale down or keep the base value as it is .. hence its very useful for fine-tuning and getting the baudrate as accurate as possible. Where PCLK is the Peripheral Clock value in Hz , U0DLM and U0DLL are the divisor registers which we saw earlier and finally DIVADDVAL and MULVAL are part of the Fractional baudrate generator register.

## 2. RESULTS AND CONCLUSION

This thesis is developed for remote monitoring of system with respect of time. Therefore user does not need go to remote area to know the temperature of device .The device developed can work efficiently up to a 30m distance depending upon surrounding environmental and 100m for open air, which can be used as a modern technique as per requirement .



**Figure 6.0**

#### **Limitations and difficulties**

- Received data in computer cannot be stored for future analyses.
- Difficulties encountered while interfacing with the Xbee module and programming of ARM7 .

#### **Future scope of work**

- To control remote system
- If system is more than one then it can form WLAN for providing information regarding data like temperature

#### **Some types of research for Xbee are used are:**

- Cosmic ray astrophysics
- Gamma ray and X -ray astrophysics
- Optical and ultra - violet astrophysics
- Infrared/sub millimeter
- Atmospheric science

---

#### **REFERENCES**

- [1] Mahesh G and Mrs. Y. Syamala, "Weather Data Logger Using ARM Processor", International Journal of Advanced Research in Computer Science and Software Engineering, Vol 3, pp. 2277-128X, JNTU, INDIA, 2013
- [2] Md. Moyeed Abrar and Rajendra R. Patil, "Multipoint Temperature Data Logger and Display on PC through Zigbee using PSoC", International Journal of Advanced Research in Computer and Communication Engineering, Vol. 2, pp. 2278-1021, AIET, Gulbarga, India, 2013

- [3] H.Vijaya Laxmi and M.Narender, "Communication b/w Mobile-Robots'and PC controller Based On ZigBee Network", International Journal of Engineering Research and Applications,Vol. 1, pp. 2248-9622, SREC Warangal, AP, India
- [4] Arun Kumar, "A Zigbee Based Wireless Datalogging System" International Journal of Scientific & Engineering Research Vol. 3, pp. 2229-5518, India, 2012
- [5] P.V. Mane-Deshmukh, B.P. Ladgaonkar, S.C. Pathan and S. S. Shaikh, " Microcontroller Pic 18f4550 Based Wireless Sensor Node to Monitor Industrial Environmental Parameters", International Journal of Advanced Research in Computer Science and Software Engineering, Vol. 3, pp. 2277 128X, Akluj, India, 2013
- [6] Nashtara Islam, Robert Watson and Philip Moore,"Z8 Encore Microcontroller Based Data Logging System",AUJT, Loughborough University Leicestershire, United Kingdom, 2006
- [7] Howitt I and Gutierrez J.A, "IEEE 802.15.4 Low Rate –Wireless Personal Area Network Coexistence Issues", IEEE Conference of Wireless Communications and Networking, Vol. 3, pp. 1481-1486, New Orleans, LA, USA, 2003.
- [8] Li J and Liu Q, "Application and Research of ZigBee Tehnology in the Miner's Lamp Monitoring", IEEE International Conference on Future Information Technology and Management Engineering, Vol. 1, pp. 317-320, Changzhou, 2010.
- [9] López M, Gómez J.M, Sabater J and Herms A, "IEEE 802.15.4 based Wireless monitoring of pH and temperature in a fish farm", 15th IEEE Mediterranean Electrochemical Conference, pp. 575-580, Valletta, 2010.
- [10] Pengfei L, Jiakun L and Junfeng J, "Wireless temperature monitoring system Based on the ZigBee technology", 2nd IEEE International Conference on Computer Engineering and Technology, Vol. 1, pp. 160-163, Chengdu, 2010
- [11] Singh R, Mishra S and Joshi P, "Pressure Monitoring in Wireless Sensor Network Using Zigbee Transceiver Module", 2nd IEEE International Conference on Computer & Communication Technology, pp. 225-229, Allahabad, 2011.

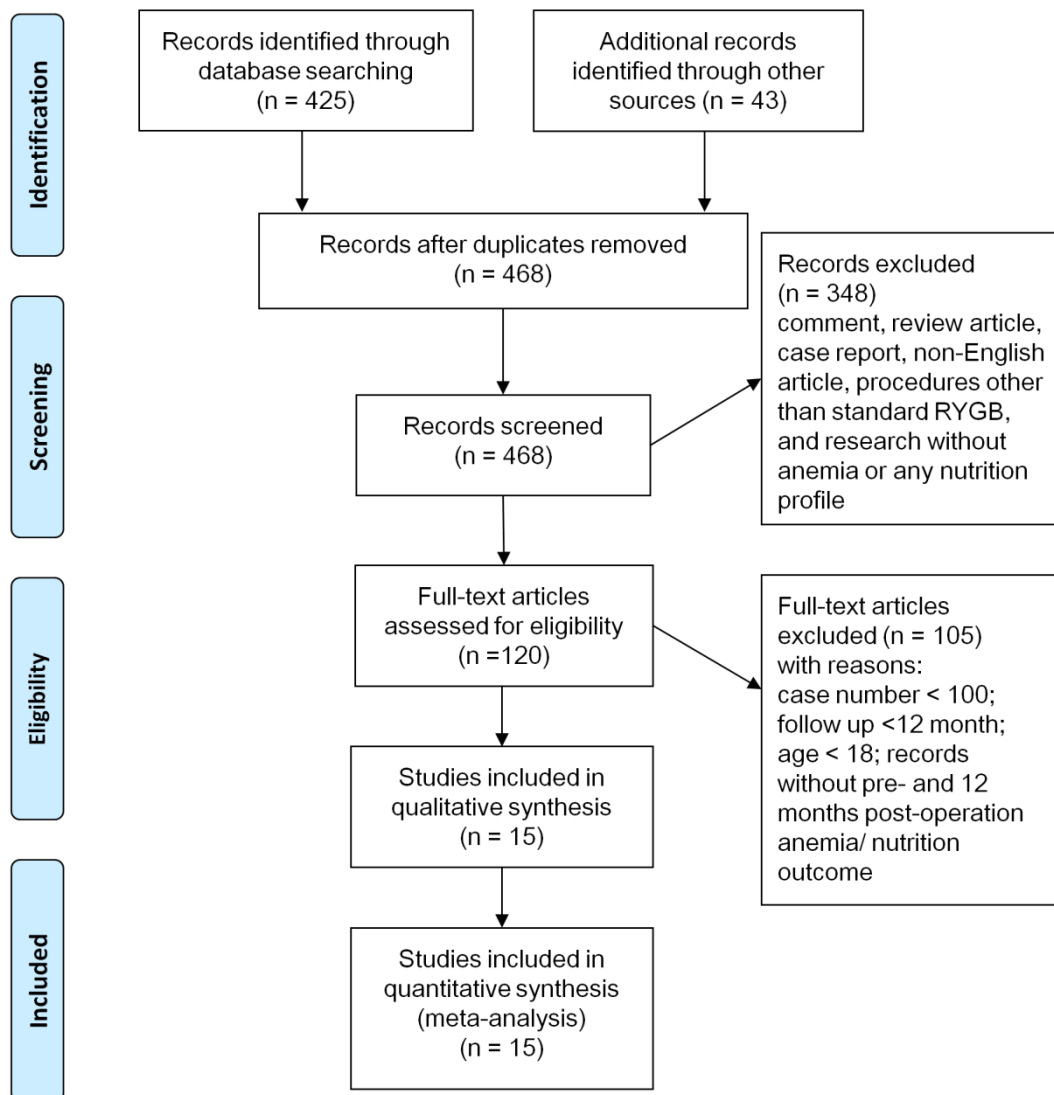
## ANEMIA AND RELATED NUTRIENT DEFICIENCIES AFTER ROUX-EN-Y GASTRIC BYPASS SURGERY: A SYSTEMATIC REVIEW AND META-ANALYSIS

Ting-Chia Weng

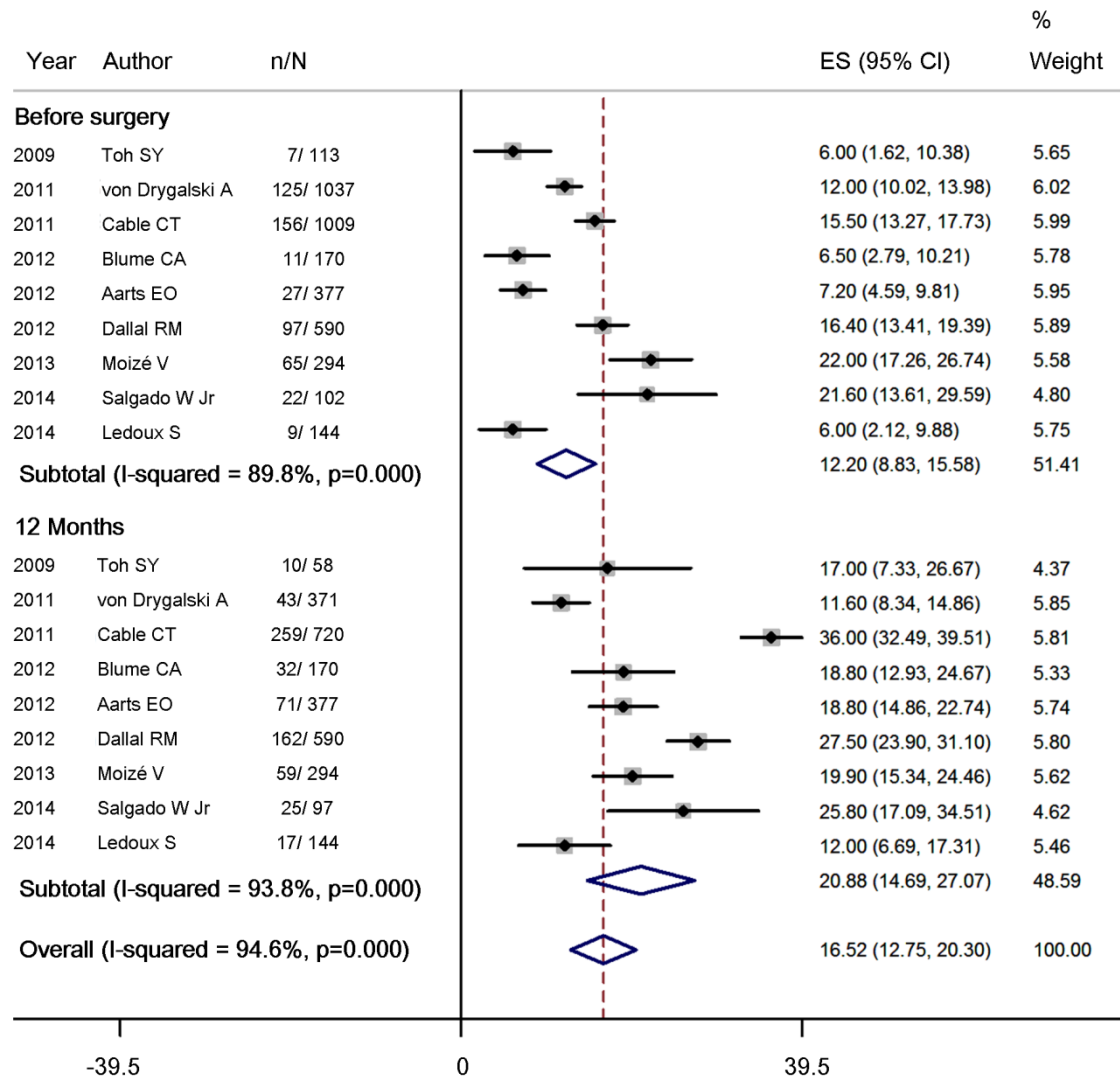
MD<sup>#1</sup>, Chia-Hsuin Chang, associate professor<sup>##</sup> equal contributions

<sup>1</sup> Department of Medicine, College of Medicine, National Taiwan University, No.1, Sec.1, Ren-ai Road, Taipei

Figure 1. Literature search and study selection

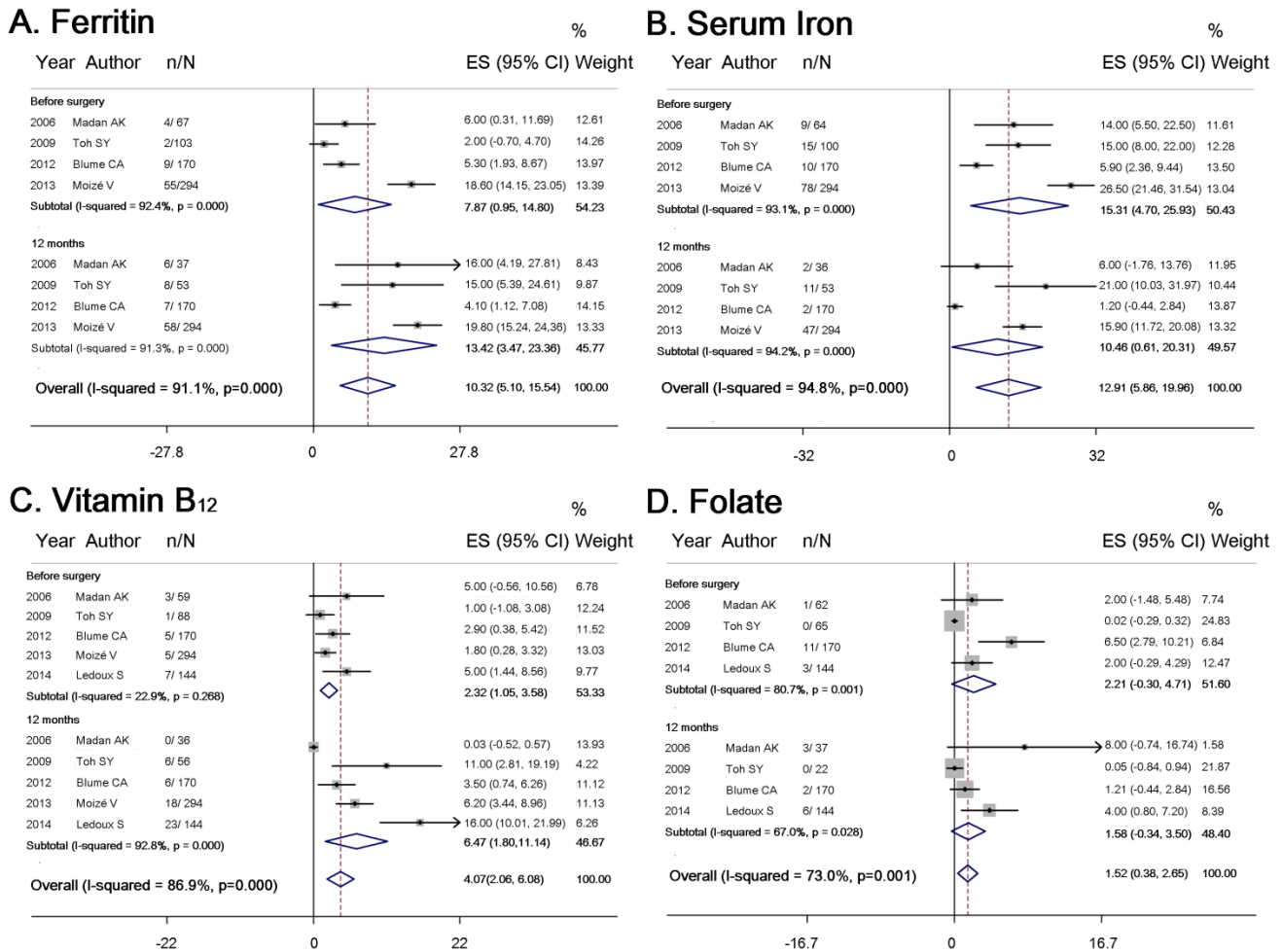


**Figure 2. Forest plot for proportion of study participants with anemia before RYGB and 12 months after RYGB**



NOTE: Weights are from random effects analysis

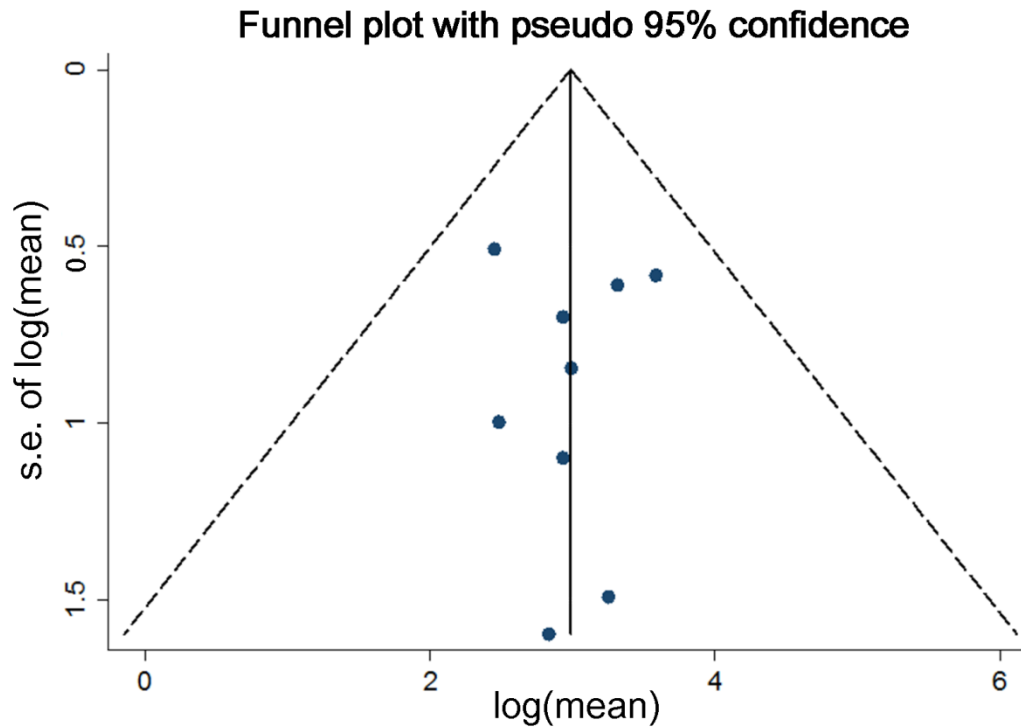
**Figure 3. Forest plot for proportion of study participants with (A) ferritin (B) serum iron (C) vitamin B<sub>12</sub> and (D) folate deficiencies before RYGB and 12 months after RYGB**



NOTE: Weights are from random effects analysis



**Figure 4. Funnel plot comparing log(mean) and s.e. of log(mean) for proportion of study participants with anemia 12 months after RYGB**



**Supporting Appendix 1A. MEDLINE (via PubMed) search query with 'All Fields'**

(gastric bypass) AND (((((((((((anemia) OR hemoglobins) OR hematocrit) OR Anemia, Iron-deficiency) OR iron) OR ferritins) OR Vitamin B 12) OR Vitamin B 12 Deficiency) OR Folic Acid) OR Folic Acid Deficiency) OR Folate)

**Supporting Appendix 1B. Cochrane Library search query with 'Search All Text'**

gastric bypass and (((((((((((anemia) OR hemoglobins) OR hematocrit) OR Anemia, Iron-deficiency) OR iron) OR ferritins) OR Vitamin B 12) OR Vitamin B 12 Deficiency) OR Folic Acid) OR Folic Acid Deficiency) OR Folate)

## PERCEIVED USEFULNESS OF DESIGN THINKING ACTIVITIES FOR TRANSFORMING RESEARCH TO IMPACT FOR FOOD SAFETY RESEARCH

Nina Veflen<sup>1,3</sup> and Antje Gonera<sup>2</sup>

<sup>1</sup> BI Norwegian Business School, Department of Marketing, Norway

<sup>2</sup> Nofima, Department of Innovation, Consumer and Sensory Sciences, Norway

<sup>3</sup> Correspondent author: [Nina.veflen@bi.no](mailto:Nina.veflen@bi.no), Phone: +47 99527775

---

### ABSTRACT:

*Empirical studies that investigate the effect of design thinking within complex contexts involving multiple stakeholders are rare. The aim of this study is to contribute to the literature on design thinking, by investigating the perceived usefulness of including design thinking activities into a complex research project for food safety. A survey was distributed to all participants in SafeConsume, a Horizon 2020 research project, to measure perceived usefulness of design thinking activities such as collaborative workshops, visualization tools and empathic observation studies. Bivariate correlations and one-way ANOVAs were conducted in JMP Pro 14. The results indicate that design thinking activities may be useful also for large food safety projects. Multidisciplinary collaborative workshops can generate optimism and a sense of belonging among the participants, visualization tools can contribute to simplify complex information, and empathic observation studies makes it easier to think user centric. This study is one of few that quantitatively investigate the perceived usefulness of implementing design thinking into a multidisciplinary research project, and the findings contribute to a better understanding of the perceived effects of implementing design thinking into a large complex food safety research projects.*

### KEY WORDS:

*design thinking; collaboration; visualization; empathy, food safety; research project; quantitative investigation*

---

**Acknowledgements:** This research was supported by the Horizon 2020 project SafeConsume (Grant Agreement 727580). We would like to thank SafeConsume WP4, particularly Designit and AHO for their contribution to the visualisations, prototypes and workshops and WP1 and WP2 for leading the observation studies.

Perceived usefulness of design thinking activities for food safety research

### 1. Introduction

Design thinking is gaining momentum within business. Evolving out of engineering and focusing on how designers approach development in their every-day activities, it has become a buzzword among business consultancies (Olsen, 2015). Recently, design thinking has also caught the interest of researchers. Attempts are made to synthesise our knowledge about design thinking (see reviews of

design thinking in D'Ippolito, 2014; Luchs *et al.*, 2011; and Micheli *et al.* 2019), and to investigate the effect of design thinking activities (see Leenders *et al.*, 2007; Seidel and Fixon, 2013; Roper *et al.*, 2016). Although, design thinking is claimed to be a successful approach for product development and innovation, we still have a way to go before we understand the impact of applying design thinking. One of the things we do not know is when design thinking is a good approach to apply and when it is not. While studies have been conducted on applying design thinking in a university context (Seidel and Fixon, 2013), for development of educational programs (Scheer *et al.* 2012; von Thienen *et al.* 2017) and in technical product and service development (Roper *et al.*, 2016; Patricio *et al.* 2018), little is known of the effect of including design thinking into research projects. One of the few papers investigating this is Gonera and Pabst (2019), who found that design thinking is an effective approach to transform scientific findings into innovations and foster collaboration across disciplines and between industry and academia.

As in many other areas, design thinking is gradually making its way into the food value chain. While design thinking for food innovation (Olsen, 2015) and design thinking for food well-being (Veflen and Ueland, 2021) have been conceptually discussed and argued to be a good thing for food innovation in the literature, we still do not know enough about the effectiveness of applying design thinking. Design thinking is an approach consisting of some core characteristics that can be fulfilled with a range of different activities. That all the different design thinking activities always will have a positive effect is unlikely. Studies that investigate the effect of different design thinking activities under specific situations are therefore needed. In this study we will investigate the effect of some specific design thinking characteristics and activities for transforming food safety research into impact.

Most existing studies focus on design thinking in a corporate (single organisation) or educational context (Calgren *et al.* 2016, 2014). The use of design thinking in science projects is not widely established. Large research and innovation collaborations, such as EU Horizon 2020 projects, must deliver on social, environmental and economic impact through innovation, collaboration, and solving wicked problems (European Commission, 2018; Mazzucato, 2018). This requires both good project management skills but also a methodology to facilitate knowledge transfer and collaboration between disciplines and stakeholders. A stream of literature exists that describes the role of orchestrators supporting the translation between disciplines but also between research and industry (Norman, 2010; Wrigley, 2016). In his opinion paper, Norman (2010) calls for the introduction of a discipline that bridges the research-practice gap "We need translational developers who can act as the intermediary, translating research findings into the language of practical development and business while also translating the needs of business into issues that researchers can address". Inspired by Norman, Wrigley (2016) coined the term of design innovation catalyst in her empirical case study of seven action researchers in industry innovation projects. The design innovation catalyst is a person or a team that facilitates innovation by introducing design thinking principles to a project or an organisation. The necessary capabilities and skills required for this includes design knowledge and skills, business knowledge and an understanding of the consumer/ user, as well as research knowledge and skills. While the studies mentioned above refer to a corporate context, Gonera and

Pabst (2019) investigated the catalyst role in several research projects within academia. In their multiple case study, they identified challenges and benefits of using design thinking in large research projects. They found for example that it is difficult to introduce an iterative and qualitative way of working to trained scientists. The different communication styles of researchers and designers and existing hierarchies and power structures in large research projects acted also as barriers to implementing design thinking. The benefits of applying a design thinking approach in a large research project lie according to Gonera and Pabst (2019) in an increased flexibility of the research process, increased user focus and better collaboration. The only study, to our knowledge, that has looked at design thinking specifically in the context of food safety is Tseklevs et al., (2019), who found that the focus on obtaining ethnographic and user-centric data was helpful in developing solutions for behavioural change necessary to reduce antimicrobial resistance in Ghanaian homes. While this study focuses on the discovery phase of design thinking and highlights the importance of user-centricity, the notion of using design thinking as a collaboration and co-creation tool is absent.

Studies that investigate the effect of design thinking within complex contexts involving multiple stakeholders, such as large research projects are missing. The aim of this study is to contribute to the literature on design thinking, by investigating the perceived usefulness of including design thinking characteristics into a large transdisciplinary research project for food safety. We want to empirically investigate and discuss how design thinking activities, such as collaborative workshops, different visualization techniques and empathic observation studies, are perceived by research participants to relate to known design thinking outcomes, such as psychological empowerment, ideation, knowledge transfer and insights.

## **2. Literature review**

### *2.1 Design thinking activities*

Over time, an agreement on the operationalisation of design thinking has evolved. Despite differences in wording, the content of the different design thinking stages seems to be approximately the same across scientific articles. Design thinking is described as an iterative, experimental, non-linear approach to development, emphasising the importance of human-centricity, visualization, and collaboration by combining what is technologically feasible, with what is desirable and economically viable (Brown, 2008; Brown and Katz, 2011; Seidel and Fixson, 2013; Liedtka, 2014; Roper *et al.*, 2016, Micheli *et al.*, 2019). The most influential applied models of design thinking, like the D-school model at Hasso Plattner Institute of Design at Stanford University, highlight the importance of being empathic with the users, defining the problem clearly up-front, ideating in multidisciplinary groups for solutions, and prototyping for visualization and continued testing (Micheli *et al.*, 2019). What first and foremost distinguishes design thinking from other innovation processes is the strong emphasis on ethnographic methods, such as observation, in-depth interviews, customer journey maps and diaries, in-depth problem learning, the use of simple prototypes to communicate ideas, and frequent experimentation and testing to fail faster (Beckman and Barry, 2007; Brown, 2008). Abductive reasoning (a logic that promotes workable solutions), a gestalt view focusing on a holistic

understanding of the problem, and reflections around the path taken from the project to the market are other characteristics of design thinking (Micheli *et al.*, 2019).

In this paper, we focus on three core design thinking characteristics: 1. Collaboration, 2. Visualization and, 3. Empathy, which are operationalized as specific design thinking activities: collaborative workshops, three specific visualization techniques and empathic observation studies.

## THE TAX LEARNING AND TAX COMPLIANCE BEHAVIOUR IN MOGADISHU, SOMALIA

**Amani Abou Zaid**

Master of International Relations & Diplomacy Supervisor: Prof.

---

### ABSTRACT

*Background: Studies on tax compliance have been carried out since the 60's. It has been studied thoroughly by academics, professionals and government agencies especially in the United States and other western countries (Sati Mariam, 1994). Research on tax compliance can be done in various fields such as accountancy, economics, criminal law, psychology, and sociology (Fischer, et al., 1992). As cited in Mohr, 2010, Alms, (1991) defined tax compliance as the reporting of all incomes and paying of all taxes by fulfilling the provisions of laws, regulations and court judgments.*

---

**Objective:** The main purpose of this study the tax learning and tax compliance behaviour in Mogadishu, Somalia.

**Finding:** The table 1 showed that the majority gender of the respondents male were 49 (61.2%) of the total respondents. The table 2 showed that the majority ages of the respondents between 20-35 years were 40 (50%) of the total respondents. The table 3 showed that the majority educational level of the bachelor of the respondents 23 and their percentage was 28.75% of the total percentage. The table 4 showed that the majority of marital status respondents single were 34 respondents and their percentage was .42.5% of the total percentage. The table 5 showed that the majority of years of experience respondents less than 1 year were 39 respondents and their percentage was .48.75% of the total percentage.

**Conclusion:** The primary objective of this study is to examine whether tax education influences the tax compliance attitude of tax payers. In order to achieve this objective, the study used quantitative research approach. Among the methods of quantitative approach, experiment and survey method of data collection was adopted. From the two approaches of experimental research, within- subjects design is employed in this study. (By :, 2011)

**Recommendation:** Based on the study findings, the study recommends that KRA should revamp taxpayer education as it impacts tax compliance positively. Particularly, the study recommends that KRA should focus using TV and radio as this are the programmes that are popular among the targeted tax payers. The study also recommends that KRA should focus on training taxpayers

### Background of the study

Studies on tax compliance have been carried out since the 60's. It has been studied thoroughly by academics, professionals and government agencies especially in the United States and other western countries (Sati Mariam, 1994). Research on tax compliance can be done in various fields such as accountancy, economics, criminal law, psychology, and sociology (Fischer, et al., 1992). As cited in

Mohr, 2010, Alms, (1991) defined tax compliance as the reporting of all incomes and paying of all taxes by fulfilling the provisions of laws, regulations and court judgments. Another definition of tax compliance is a person's act of filling the Income Tax Form, declaring all taxable income accurately, and disbursing all payable taxes within the stipulated period without having to wait for follow-up actions from the authority (Singh, 2003). Roth et al. (1989), as cited in Singh, 2003, explained that taxpayers need to prepare all the relevant information in the Income Tax Form within the period given, and the form must report accurate tax liability in accordance with the need of laws, regulations, and court judgments. Those who fail to adhere to taxation laws intentionally or otherwise shall be considered as having committed an offence. Jackson and Million (1986), as cited in Mohr (2010), listed 14 main factors that have influenced tax compliance as discussed by various researchers. These factors are age, gender, education, income, occupation or status, peers' or other taxpayers' influence, ethics, legal sanction, complexity, relationship with taxation authority (IRS), income sources, perceived fairness of the tax system, possibility of being audited and tax rate. Various researchers have listed factors that influenced tax compliance such as demographic, income, compliance cost, and tax agents, in addition to moral or ethical factors (Singh, 2003; Kasi Pillai et al., 2003). Other researchers (Sour, 2002; Keller, 1997; Trivedi, 1997; Hamm, 1995; Chang et al., 1987), as cited in Kasi Pillai, Nor Hani, and Noor, 2003, listed enforcement element factors (such as penalty, 2 audit, and tax rates) as having a great influence on tax compliance behaviours. Tax compliance

#### Problem statement

This chapter is organized in eight sections. The first Section presents the study's statement of problem. The second section deals with stating the purpose of this quantitative study. Under section three, the two hypotheses which are tested in this study are presented. Following this section, the research methodology which is utilized in this study to achieve the research objective is presented. The fifth section briefs the significance of this study. The scope and limitation of 3 this study are presented under section six and seven respectively. Finally, the last section briefs about how this study is organized.

Tax compliance is growing international concerns for tax authorities and public policy makers as tax evasion seriously threatens the capacity of government to raise public revenue. Taxpayers will readily accept any new system introduced if they have ample knowledge to understand the system (Kasi Pillai, Nor Hani, and Noor, 2003). Thus, education programs organized by custom and duty authority or public education institutions are required to enhance taxpayers' ability to understand the importance of tax on country's economic development and to increase their confidence in fulfilling their responsibilities as taxpayers. It is clear that developing tax knowledge in taxpayers is an important element in operating a successful tax system. Achieving an appropriate voluntary compliance level could be achieved if taxpayers can complete the tax returns correctly and pay the right amount of taxes. Thus to realize the objectives of voluntary compliance, taxpayers need to be informed, well educated (particularly in tax matters), and their tax literacy level needs to be enhanced

on a regular basis to keep their knowledge up to date and relevant. However, less attention has been directed toward understanding precisely how education will influence tax payer's attitude towards tax compliance in Ethiopia. Hence, the

influence of education on tax compliance attitude must be investigated and the findings of this study can be used to inform sound public policymaking. (By ;, 2011)

General objective/ aim/purpose

The main purpose of this study the tax learning and tax compliance behaviour in Mogadishu, Somalia

Specific objective

1. To identify the relationship between tax learning and tax compliance behavior in Mogadishu, Somalia
2. To determine the tax learning in Mogadishu-Somalia.
3. To evaluate the tax compliance behavior in Mogadishu-Somalia.

## METHODOLOGY

### DATA ANALYSIS PROCEDURE

Questionnaires received from respondents and interview schedules were checked for completeness to maintain the number of respondents. Statistics package for social scientists (SPSS) was used to analyze data collected through questionnaires. Frequencies and percentages

## CONCLUSION

The primary objective of this study is to examine whether tax education influences the tax compliance attitude of tax payers. In order to achieve this objective, the study used quantitative research approach. Among the methods of quantitative approach, experiment and survey method of data collection was adopted. From the two approaches of experimental research, within- subjects design is employed in this study. (By ;, 2011)

## RECOMMENDATION

Based on the study findings, the study recommends that KRA should revamp taxpayer education as it impacts tax compliance positively. Particularly, the study recommends that KRA should focus using TV and radio as this are the programmes that are popular among the targeted tax payers. The study also recommends that KRA should focus on training taxpayers on the tax amendments and tax laws as the taxpayers seem to have little knowledge on the same. (No Title, 2020)

"Governments need money. Modern governments need lots of money." (Steinem 1993:1) Collecting this money is a tricky problem because incentives for tax evasion are pervasive. Governments have tried various approaches to tackling this problem. I recommend the following policies to tackle the problem: Positive rewards; - Material rewards usually come in the guise of lotteries. For instance, Taiwan operates a Receipt-based tax lottery to increase sales tax (VAT) compliance since the 1950s.



China introduced a VAT-lottery in the 1990s (Wan 2010). More recently, some European countries followed suit including Malta, Slovakia, Portugal, and Romania (Foo ken et al. 2014). (Personal & Archive, 2017)

---

**REFERENCE:**

1. By : (2011).
2. Community-based and customary taxation in south-central Somalia : Possibilities for hybrid governance and DIALOGUE programming. (n.d.).
3. Fowles, J. (2012). PUBLIC MANAGEMENT AS CITIZEN COMPLIANCE: A CASE STUDY OF INCOME TAX COMPLIANCE BEHAVIOR IN THAILAND By.
4. No Title. (2020).
5. Personal, M., & Archive, R. (2017). The Effect of Taxpayer Education on Tax Compliance in Kenya .( a case study of SME ' s in Nairobi Central Business District ). 80344.
6. Ritei, J., & Sporta, F. (2022). Effect of Taxpayer Education and Law Enforcement Strategies on the Level of Tax Revenue in Kenya. 13(3), 15–20. <https://doi.org/10.9790/5933-1303041520>
7. Science, A. (2021). Examining the Effect of Tax Understanding and Tax Awareness on Taxpayer Compliance in Kabul-Afghanistan Afganistanda ' ki Vergi Anlayışı ve Vergi Bilincinin Mükellef Uyumu Üzerindeki Etkisinin İncelenmesi : Kâbil Örneği. 56(1), 148–162. <https://doi.org/10.15659/3.sektor-sosyal-ekonomi.21.02.1445>
8. Deyganto, K. O. (2018). Determinants of Tax Compliance Attitude with Taxation : Evidence from Category “ A ” Taxpayers in Gedeo Zone , SNNPRS ,. 2014, 32–44.
9. Mwakabungu, H. B., & Salaam, D. E. (2022). EFFECT OF TAXPAYER EDUCATION ON VOLUNTARY TAX COMPLIANCE BY VALUE ADDED TAX ( VAT ) TAXPAYERS IN DODOMA , TANZANIA EFFECT OF TAXPAYER EDUCATION ON VOLUNTARY TAX COMPLIANCE BY VALUE ADDED TAX ( VAT ) TAXPAYERS IN DODOMA , TANZANIA B . H . P . MWAKABUNGU. January 2016. <https://doi.org/10.13140/RG.2.2.29519.97446>
10. No Title. (2019).
11. Ejakait, M. A. (2011). LOW ER K A B S Y8 U B R A S Y.
12. Impact, T. H. E., Tax, O. F., Programs, E., Tax, O. N., & Among, C. (2022). THE IMPACT OF TAX EDUCATION PROGRAMS ON TAX COMPLIANCE AMONG. 26(2), 56–63.

## INVESTIGATION OF RICE HUSK ASH CEMENTITIOUS CONSTITUENT IN CONCRETE

Oyejobi, Damilola Oyewumi , Abdulkadir, Taofeeq Sholagberu and Ajibola, Victor Motolani

*Department of Civil Engineering, University of Ilorin, Ilorin, Nigeria*

---

### ABSTRACT:

*This research evaluates rice husk ash (RHA) as a cementitious constituent in concrete productions. Raw rice husk obtained from rice mill situated in Ilorin metropolis, Kwara State, Nigeria was burnt in a furnace at a controlled temperature of 700oC for a period of four hours. The ash was analysed for its physical and chemical properties. The mechanical performance of the ash in the concrete was investigated when used as a partial replacement for cement in concrete at 10%, 20% and 30% respectively with a control test that contains 0% RHA. Experimental findings showed that the RHA can be categorized as N-class pozzolana according to ASTM C618-12. The workability of the concrete falls as the RHA content increases. It was also observed that the compressive strength of Rice Husk Ash Concrete (RHAC) increases with curing age but decreases as the percentage of cement replacement with ash increases. The density of the concrete produced also reduces even with age as the percentage replacement of cement with ash increases. The optimum compressive strengths of RHAC are 25.80 N/mm<sup>2</sup>, 22.73 N/mm<sup>2</sup> and 19.6N/mm<sup>2</sup> while the corresponding densities are 2449.67Kg/m<sup>3</sup>, 2348.33Kg/m<sup>3</sup> and 2265.67Kg/m<sup>3</sup> respectively at 10%, 20% and 30% at 28 days curing age when compared with the control test which is 27.47 N/mm<sup>2</sup> and 2517.67 Kg/m<sup>3</sup>. These values for RHAC produced can therefore be used for reinforced concrete with either normal or lightweight aggregates. This will not only improve the quality of the concrete but also reduce drastically burning of agricultural waste that causes environmental pollution.*

### KEYWORDS:

*Pozzolana, RHA, compressive strength, environmental pollution, workability*

---

### INTRODUCTION

Rice husk (RH) is the outer layer covering of the rice grains that is obtained during the milling process. This is usually being thrown away to the landfill without further use, thus, contribute to environmental pollution. RH constitutes 20% of weight of the total rice produced and the husk composed of

28 - 38% of cellulose, 9 - 20% of lignin, 18.80 - 22.30% of silica and 1.9 -

3.0% of protein (Anbu and Nordin, 2009). Rice husk ash (RHA) is a by-product from the burning of rice husk under controlled temperature and burning time. RH has been used as a highly reactive pozzolanic material leading to a significant improvement on strength and durability of normal concretes (Bui, 2001)[2]. It is extremely prevalent in East and South-East Asia because of the rice production in these areas (Nick, 2009)[3]. Also, rice constitutes one of the major crops produced in Nigeria. Statistics have shown that it is the fourth major cereal in Nigeria after sorghum, millet and

maize in terms of output and cultivated land area. It is a major staple and most popular cereal crop of high nutritional value grown and consumed in all ecological zones of the country. The average Nigerian now consumes about 24.8 kg of rice per year representing 9% of the total calories intake. In spite of its contribution to the food requirements of the Nigerian population, rice production in the country is put at about 3.2 million tonnes (Babafada, 2003).

Disposal of the husks is a big problem and open heap burning is not acceptable on environmental grounds, and so the majority of husk is currently going into landfill. These are utilized as fuel in some regions, while they are regarded as wastes in other regions causing environmental pollution. When burnt under controlled conditions, the RHA is highly pozzolanic and very suitable for use in lime-pozzolana mixes and for Portland cement replacement (Yogenda and Jagadish, 1974). Otherwise, the ash which is essentially silica will be converted to crystalline forms and becomes less reactive. It has been tested and found that the ideal temperature for producing excellent results is between 600 °C and 700 °C (Nick, 2009). In line with (Sima, 1974) definition, Rice husk has been recognized as pozzolona because siliceous and aluminous materials in has little or no cementitious value, but in finely divided form and in the presence of moisture, chemically reacts with calcium hydroxide liberated during the hydration of Portland Cement to produce stable, insoluble cementitious compound which contributes to its strength and impermeability. RH has a high concentration of silica, generally between range of 80-85% (Siddique, 2008).

Researchers have shown that small amounts of inert filler have always been acceptable as cement replacement. Silica fume, fly ash, met kaolin, palm kernel ash, sugarcane bagasse ash and ground granulated blast furnace slag are well established wastes with pozzolans. (Megat et al., 2008) investigated the effect of silica fume, metakoalin, fly ash and granulated blast fume on workability, compressive strength, elastic modulus and porosity of high strength concrete.

Some of the advantages of using pozzolans in concrete includes improvement in workability of concrete at low replacement levels and with low carbon content, reduced bleeding and segregation, low heat of hydration, lower creep and shrinkage, high resistance to chemical attack at later ages (due to lower permeability and less calcium hydroxide available for reaction) and low diffusion rate of chloride ions resulting in a higher resistance to corrosion of steel in concrete. (Feng et al., 2004) found out that various metal ions in the husk and unburned carbon influence the purity and colour of the ash.

The chemical analysis of RHA obtained in Malaysia has 96.7% Silicon dioxide (SiO<sub>2</sub>) with 0.91% of potassium oxide (K<sub>2</sub>O), and has some minor oxides such as alkalis, sulphate and calcium oxide. The sum of these oxides i.e.

SiO<sub>2</sub> + Al<sub>2</sub>O<sub>3</sub> + Fe<sub>2</sub>O<sub>3</sub> of RHA were 97.8% (ASTM, 1978). Thus, classified as pozzolan in accordance with American Standard for Testing Materials (Kartin, 2011) that specify 70% minimum for SiO<sub>2</sub>. Controlled burning of the husk after removing these ions with an acid leaching can produce white silica of high purity that is amorphous, reactive, and characterized by high surface area and pore volume. Acid treatment has been found to decrease the degree of crystallization of silica and carbon in rice husks reducing the sensitivity of the pozzolanic activity of the rice husk ash to burning

conditions. This study investigates the cementitious properties of RHA as partial cement replacement in concrete to come up with the optimum percentage replacement of RHA with cement.

#### Materials and methods

The materials used in this research work are rice husk, Ordinary Portland Cement (OPC), aggregates (fine and coarse) and water.

#### Rice Husk

This was collected from the rice mill situated at Oja-gboro in Ilorin metropolis, Kwara State, Nigeria.

#### Ordinary Portland Cement

Elephant cement which belongs to Ordinary Portland Cement family was used and is in accordance with BS (BS EN, 2000).

#### Fine Aggregate

This was sourced from a construction site in the university of Ilorin premises and is in accordance with BS (BS, 1992).

#### Coarse Aggregate

This was sourced from a construction site in the University of Ilorin premises. It is also in accordance with BS (BS, 1992).

#### Water

Clean and drinkable water which is clear from impurities and is in accordance with BS (BS, 2002). was used.

The rice husk was burnt at a temperature of about 700°C using a controlled blast furnace for a period of four hours. The burning was done at the Fabrication Workshop, Department of Mechanical Engineering, Institute of Technology, Kwara State Polytechnic, Ilorin, Nigeria. Figures 1, 2 and 3 showed raw RH, processed RHA and the controlled furnace respectively. The burnt ash was grinded using mortar and pestle and was sieved using 0.09mm sieve. Chemical analysis of the processed RHA was carried out in the Chemistry laboratory, Department of Chemistry, University of Lagos, Lagos State, Nigeria (using Atomic Absorption Spectrophotometer) to determine the chemical composition of the ash. Physical test like water absorption capacity, particle size distribution, specific gravity,

moisture content, fineness test were also carried out on the aggregates and the ash. Also, the design mix ratio for the concrete casting was calculated. This was used to cast concrete cubes of size 100mm x 100mm x 100mm at different RHA replacement level i.e. 0%, 10%, 20% and 30%. The cubes were cured for 7, 21 and 28 days at the room temperature of  $(27 \pm 2)$  oC and their corresponding compressive strengths were determined using a compressive strength testing machine. The densities of the concrete for different RHA replacement levels were also determined.

**HEMŞİRELERİN PROFESYONEL DEĞERLERİ VE ETKİLEYEN FAKTÖRLER****Tuğbağ SUBAŞI, Gamze ÖZBEK GÜVEN**

Professional Values of Nurses and Affecting Factors

**ABSTRACT:**

*Nursing is a profession that emergence of human needs, prioritizes, protects, maintains, improves the health of the individual, family and society, and provides care in situations that negatively affect health. Nursing, which dates back to human existence, has become a profession that adapts to time, constantly renews and develops itself, and requires multi-directional thinking and acting, without changing its goals, changing its practices and training. The nursing profession has provided the formation of nursing behaviors, philosophies and values in this development process. Nursing has become a profession with values and ethical principles. The world we live in is constantly changing due to many factors such as war, natural disaster, climate change, epidemic disease. Nursing needs to preserve its values in order to both survive and develop in an ever-changing world. For this reason, it is important to reveal the values of the nursing profession, its importance in the nursing profession, why it is necessary and how it contributes to its development, and to carry these values to the new generation nurses.*

**KEYWORDS:**

*Nursing, Nursing values, Professional values.*

**ÖZET**

Hemşirelik, insan gereksinimlerinden doğan, birey, aile ve toplumun sağlığını önceleyen, koruyan, sürdüren, geliştiren ve sağlığı olumsuz etkileyen durumlarda bakım vermek amacıyla uygulanan bir meslektir. Başlangıcı insan varoluşuna kadar uzanan hemşirelik, amaçlarını değiştirmeden, uygulamalarını ve eğitimlerini değiştirerek zamana uyum sağlayan, kendini sürekli yenileyen ve geliştiren, çok yönlü düşünmeyi, davranmayı gerektiren bir meslek olmuştur. Hemşirelik mesleği bu gelişme sürecinde, hemşirelik davranışlarının, felsefesinin, değerlerinin oluşmasını sağlamıştır. Hemşirelik, değerleri ve etik ilkeleri olan bir meslek haline gelmiştir.

Yaşadığımız dünya savaş, doğal afet, iklim değişikliği, salgın hastalık gibi birçok faktör nedeniyle sürekli bir değişim içerisindedir. Hemşireliğin, sürekli değişen dünyada hem varoluşunu sürdürebilmesi hem de geliştirebilmesi için değerlerini koruması gereklidir. Bu nedenle hemşirelik mesleğinin değerlerini, hemşirelik mesleğindeki önemi, neden gerekli olduğu ve gelişmesine nasıl katkı sağladığı ortaya koymak ve yeni nesil hemşirelere bu değerleri taşıyabilmek önemlidir.

Anahtar Kelimeler: Hemşirelik, Hemşirelik değerleri, Profesyonel değerler.

## GİRİŞ

Hemşirelik, insanlara yardım etmek ve bakım ihtiyaçlarını karşılamak amacıyla uygulanan bir meslek olup tarihsel süreçte amaçlarını değiştirmeden, içinde bulunduğu zamana uyumlu şekilde eğitimlerini ve uygulamalarını yenilemekte, kendini sürekli geliştirmektedir (1,2).

Hemşirelik mesleğinde çok yönlü düşünmek ve davranmak, bireylerin bakım gereksinimleri belirlemek ve bunları karşılayarak onlara faydalı olabilmek için doğru kararlara ve bu kararları alabilecek özelliklere sahip olmak gerekir (3). Hemşirelerin doğru kararlar almaları ve doğru uygulamalarda bulunmalarında ise profesyonel değerleri rehber ve yol gösterici olarak ön plana çıkar (4-7).

Bu çalışma da hemşireliğin profesyonel değerleri üzerine yapılan çalışmalar incelenerek, bu değerlerin hemşirelik mesleğinde önemi, neden gerekli olduğunun, bakım kalitesinde ki rolünü ortaya koymak, gelişmesine nasıl katkı sağladığını tespit etmek ve ileri düzey çalışmalar için güncel veri kaynağı sağlamak amaçlanmaktadır. Çalışma geleneksel terleme türündedir.

### Hemşirelik Mesleğinde Değer Kavramı

Başlangıcı insanlık tarihi kadar eski olan hemşirelik, bilimsel bilgiler ışığında kendini sürekli yenileyip, geliştirerek bakım ve karar verici, koruyucu/gözetici ve savunucu, yönetici, rehabilite edici, rahatlatıcı, eğitici ve danışmanlık gibi pek çok işlev ve rolleri olan bir meslek haline gelmiştir (4).

Hemşirelik mesleğinin tarihsel gelişimi incelendiğinde, akla gelen ilk isim Florence Nightingale'dir. Onun sağlık alanında liderlik ettiği birçok araştırma ve uygulamalar gelecek yıllara ışık tutmuştur (5). Hemşirelikte bilimsel araştırmalar kendini yenilemesini, hemşirelerde farkındalık oluşturmasını, hemşirelik davranışlarının şekillenmesini, felsefesinin, değerlerinin oluşmasını sağlamıştır. Daha kaliteli bakım anlayışıyla çalışmalar yapılarak ve eğitim, bilim, profesyonellik gibi kavramlarla destek sağlanarak mesleğin ilerlemesi gerçekleşmiştir.

Bazı hemşire liderler, hemşireliğin meslekleşme sürecine hemşirelik kuramları ile katkı sağlamışlardır. Bunlardan Hildegard Peplau, hemşirelik alanında kişilerarası ilişkiler üzerine odaklanmıştır. Hemşireliği eğitsel, tedavi edici ve kişiler arası süreçler aracılığı ile geliştikçe olgunlaşan bir güç olarak görmüştür. Hemşireler, ihtiyaç duyulduğunda, bireylerle kişisel bir ilişki içine girerek bakım vermektedirler. Hemşirelik mesleğinin temelini oluşturan bakımın iyi niyet, sempati ve merhametten fazlasını içeren ve insan ilişkilerinin önemli bir parçası olan katılımcılıkla ilgili olduğunu düşünmüştür (6-8). Diğer bir kuramcı Leininger'e göre hemşire; hastalara yardım sağlayan, iyileştirme yeteneği olan, bıkmadan ve sevecen davranışlarıyla hastalara bakım vermek için eğitim almış kişidir. Bakım olmadan iyileşmenin mümkün olamayacağını söylemiştir. Hemşirenin amacı; kültürel değerler, inançlar ve uygulamalarla tutarlı bir bakım sağlamaktır. Hemşire bu nedenle, kültürlere özel bakım sağlamanın temelini oluşturan, farklı kültürlerin değerlerini, sağlık inançlarını ve hayat tarzlarını anlamaya çalışmalıdır (9). Henderson ise hemşireliği; bireylerin yapamadığı faaliyetlerine yardımcı olmak olarak tanımlamıştır ve insanın temel gereksinimlerinden bahsetmiştir. Hemşireliğin sanatsal yönünden, sağlıklı/hasta bireyleri çevreleriyle ele alarak gerekli bakımın sistemli bir yaklaşımla sağlanacağına vurgu yapmıştır (10).

Hidegard Peplau, Leininger ve Henderson gibi kuramcılarının bu söylemlerinin temelinde mesleki değerler yer almaktadır. Değerler bir mesleğin sahip olması gereken yapı taşları gibidir. Hemşirelik

tarihsel süreç içinde değerleri ve etik ilkeleri olan bir meslek haline gelmiştir (4). “Değer” kelimesi, nesneye karşılık olarak verilen, kabul edilen ve olması gereken, arzu edilen şey anlamına gelmektedir. “Bir şeyin kendisiyle aynı cinsten olan şeyler arasındaki özel yeri” olarak tanımlanan “değer”, istenilen veya ödüllendirilen bir nitelik/ölçüttür. Nesnelere veya eylemlere yönelik olarak iyi-kötü, doğru-yanlış, güzel-çirkin, günah-sevap ve bunun gibi nitelermelerden “değer önermeleri” kurulur ve bu önermelere göre değerlendirme yapılır (11). Örneğin; bireylerden toplum içinde uymaları istenen, yapılmasına izin verilen, toplumun geneli tarafından benimsenen davranışlar “iyi”, bunun karşıt davranışları ise “kötü” olarak nitelendirilir.

Bir eylemin iyi ve kötü ya da doğru ve yanlış olarak ayrımı değerlerle mümkündür. Bu nedenle, değerler; kişinin kendini ifade edebilmek için seçtiği, davranış, düşünce, inanç, duygu ve bilinç bütünlüğüdür. Davranışlara yön veren ilkelerdir (12). Babadağ’a göre hemşirelerin, yaşamın en değerli varoluşu kabul edilen insanın yaşamına, onuruna, kişiliğine, değerlerine ve özerkliğine saygı duyarak kaliteli bakım uygulayabilmesi için kişisel ve mesleki davranışlarını yönlendiren değerlerini farkında olması çok önemlidir (13). Çünkü değerlerin hemşirelerin düşünme ve davranış biçimleri üzerinde büyük etkisi vardır.

#### Kişisel Değerler

Bireylerin yaşamlarında edindikleri deneyimlerin, kendilerine ait özelliklerle şekillenmesiyle oluşan değerlerdir. Kişisel değerler çevreden, sosyal olaylardan, yaşanan ve edinilen deneyimlerden, içinde bulunulan ortam, aile, grup kültürlerinden etkilenir (14). Kişisel değerler, mesleki değerlerle tutarlı olabilir ve bireyin meslek seçimini etkileyebilir.

#### Mesleki Değerler

Mesleki değerler, uygulayıcılar ve profesyonel gruplar tarafından benimsenmiş, onların tutum ve davranışlarına rehberlik eden standartlardır. Bu değerler kökenlerini mesleki etik değerlerden alırlar ve kişisel değerlerin yansıması ile oluşmaktadır (15). Mesleki değerler bireylere mesleğe ait verilen eğitim sırasında kazandırılır. Uluslararası Hemşireler Birliği (ICN) ve Amerikan Hemşireler Birliği (ANA) tarafından “yararlılık, özgecilik, estetik, eşitlik, özgürlük, insan onuru, adalet, doğruluk” temel mesleki değerler olarak belirlenmiştir (16,17).

Mesleki değerler, kişinin eylem tercihlerini belirleyen önemli faktörlerden birisidir ve meslek üyelerine kazandırılması önem taşımaktadır (15). Sağlam/hasta bireylere bakım verirken, problemi tanılama ve çözüm üretme yollarını planlamada hemşirelerin mesleki değerleri etkilidir. Bunun için de profesyonel değerleri arttırmaya yönelik eğitimlerin planlanması, eksik yönlerin giderilmesine yönelik çalışmalar yapılması bakım kalitesinin artırılması açısından önemlidir (6,18,19).

#### Hemşirelerin Değerlerini Etkileyen Faktörler

Hemşirelerin sağlık bakım hizmetleri sırasında karşılaştıkları ahlaki sorunlara çözüm üretme süreçlerinde kişisel değerinden daha çok mesleki değerleri ön plandadır (20). Ancak mesleki değerler de kişisel değerlerden etkilenir. Bu nedenle kişisel değerleri farkında olmak, mesleki eğitim sırasında verilecek olan değerler eğitiminin benimsenmesi açısından önemlidir (19).



Profesyonel deęerleri kltr, eęitim, mesleki kıdem, pozisyon ve uzmanlık alanı, alıřılan birimin zellięi ve alıřma kořullarının etkiledięi belirlenmiřtir (21,22). zellikle hemřirelerin eęitim dzeylerinin yksek olması ve sadece gndz alıřmaları mesleki deęerlerini olumlu ynde etkiledięi deęerlendirilmiřtir (20). Hemřirelerin mesleki deęerlerinin niversite hastanesinde alıřanlarda, lisansst eęitim mezunu olanlarda, sadece gndz/gece vardiyasında alıřanlarda, sorumlu hemřirelerde ve mesleęinden memnun olanlarda daha yksek olduęu saptanmıřtır. Ancak birok deęiřkene raęmen sadece hemřirelerin alıřtıkları pozisyonun ve eęitim seviyelerinin mesleki deęerlerini etkileyen nemli faktrler olduęu ortaya konulmuřtur (23).

Griř ve arkadařları cinsiyet, yař, medeni durum, eęitim durumu ve iř deneyimi gibi faktrlerin mesleki deęerleri etkilemedięi ancak hemřirelerin bilimsel bilgileri takip etmeleri, bilimsel toplantı ya da kongrelere katılmaları ve mesleki bir derneęe ye olmalarının nemli olduęunu bildirmiřlerdir. Hemřirelerin profesyonel deęerlerinin geliřtirilmesi iin dzenli aralıklarla eęitimlerin tekrarlanması gerektięini nermiřlerdir (24). Benzer alıřmalarda Kaya ve Kantek ile Demir ve Yıldırım da eęitim ile mesleki deęerler arasında pozitif bir iliřki olduęu sonucuna ulařmıřlardır (15,18). Uslu ve Kızılkaya'da alıřmalarında hemřirelik eęitim srecinde profesyonel deęerlerin kazandırılmasına ynelik etkinliklerin planlanması gerektięini vurgulamıřlardır (4).

Hemřirelik insani deęerler zerine inřa edilmiř bir meslektir. Bu nedenle hemřirelik mesleęinin deęerleri dnyanın her yerinde benzer olmakla beraber kltrel farklılıklardan etkilenir. Bu etkilenme deęerlerin kltrlere gre farklı ncelenmesinden kaynaklanır. rneęin; Rassin'in alıřmasında "insan onuru, hastalar arasındaki eřitlik ve acıların nlenmesi", İran'da yapılan benzer bir alıřma da "hastanın gizlilięinin korunması ve srdrlmesi", lkemizde yapılan bir alıřmada ise "gven ve adalet" deęerleri daha fazla ncelikli deęer olarak bulunmuřtur (22).

Hemřirelik ęrencileri, yeni mezun hemřireler ve profesyonel hemřirelerin karřılařtırıldıęı alıřmalarda hemřirelik deęerlerinin (etik, mesleki deęerler...) yařla orantılı olduęu, yař azalırken neminin azaldıęı, benlik ifadelerinin arttıęı belirlenmiřtir (27). Saęlıklı ve sosyal iliřki deęerlerinin (kiřisel iliřkiler, arkadařlıklar, grup ii iliřkiler...) ise ęrenciler ve gen hemřirelerde daha n planda olduęu grlmřtr. ęrenci gruplarında, mesleki deęerler dięer gruplardan daha dřk bulunmuřtur (25). Bu nedenle hemřirelik ęrencilerine, deęerlerin ve etik duyarlılıęın kazandırılmasına ynelik etkili eęitim ieriklerinin dzenlenmesi gereklidir. rneęin Amerika Birleřik Devletleri'nde, bazı hemřirelik okullarında semeli olarak "Hemřirelikte G: İyileřtirici Sanatı" dersi okutulmaktadır. Bu ders hemřirelerin ve eęitmcilerin, ęrencilere meslek seiminde hemřirelik deęerlerini anlamaları, arařtırmaları, geliřtirmeleri ve baęlılıklarını saęlamak iin oluřturulmuřtur. Ders sonrası yapılan deęerlendirmelerde; dersin dięer ders konularından farklı bulunduęu, gemiř deneyimlerin dinlenmesi ve kendi deneyimlerinin paylařılması ile etkili bir eęitim ve ęrenim sreci yařandıęı bildirilmiřtir (26).

Meslek hakkındaki dřncelerin profesyonel deęerlere ynelik tutumları etkiledięi belirlenmiřtir. Hemřirelik mesleęinin benimsenmesi, elde edilen maddi kazanç ve hastane ynetiminin alıřan personele sunduęu imknların bakıř aısını ve davranıřları etkiledięi grlmřtr (27). Yine eęitim dzeyi, alıřma yılı, nbet tutma durumu, tutulan nbet sayısı, bilimsel faaliyetlere katılım, mesleęini sevme gibi durumların profesyonel deęerler zerinde etkili olduęu bildirilmiřtir. Olumlu sonular elde

etmek için, bilgilendirme toplantıları düzenlemenin, çalışma ve dinlenme saatlerinin çalışanların sosyal hayatının düşünülerek planlanmasının, kongre, seminer gibi faaliyetlere katılımlarının desteklenmesinin, mesleki üyeliklere yönlendirilmelerinin gerekli olduğu düşünülmüştür (28). Benzer bir çalışma da Yayla ve arkadaşları tarafından yapılmıştır. İki farklı kültür grubu olarak Türkiye ve İran'daki hemşireler karşılaştırılmıştır. Çalışma saatleri ve hasta sayıları iki ülkede anlamlı bir şekilde farklı iken, ulaşılan sonuçlarda benzerlik bulunmuştur. Hemşirelerin çalışma şartlarına yönelik iyileştirme ve mesleki bilgilendirme programlarının oluşturulması, iş tanımlarının belirlenerek düzenlenmesi, seminer, kongre gibi mesleki eğitim ve sosyal programlara katılımın desteklenmesi tavsiye edilmiştir (29).

Uzun süreli stresli bir ortamda çalışmak iş tatminin azalmasına ve kronik bir duygusal sıkıntı yaşanmasına sebebiyet verebilir. Çalışmalar hemşirelerin iş koşulları nedeniyle diğer sağlık çalışanlarına göre daha yüksek tükenmişlik yaşadıkları ve yaşadıkları tükenmişliğin yoğunluğuna bağlı olarak işten ayrılma niyetlerinin olduğunu göstermektedir (30–32). Aynı zamanda mesleki değerler tükenmişlik duygusundan etkilenmektedir. Çin Halk Cumhuriyeti'nde yapılan çalışma; onkoloji hastanesinde görev yapan hemşirelerin mesleki ve profesyonel değerlerinin nasıl etkilendiği incelenmiştir. Duyarsızlaşma, kişisel başarılar ve duygusal tükenme puanları karşılaştırılmıştır. Tükenmişlik seviyesinin yüksek olduğu görülmüştür. Aynı zamanda bakım, karar verme, sorumluluk, güvenilirlik değerleri arasında ise bakımın pozitif yönde ilk sırada yer aldığı görülmüştür. Tükenmişlik hissiyatının mesleki değer algısı artırılarak iyileştirilebileceği, bunun için değerler eğitimlerinin güçlendirilmesi ve tükenmişlik düzeylerini azaltmaya yönelik stratejiler geliştirmenin önemi belirtilmiştir (33).

## SONUÇ

Hemşirelik mesleğinin gelişme sürecinde, hastaların bakım ihtiyaçlarını karşılamak için gerekli uygulamalar sürekli kendini yenilemiş, hemşirelerde farkındalık yaratarak, hemşirelik davranışlarının, felsefesinin, değerlerinin oluşmasını sağlanmıştır. Daha kaliteli bakım anlayışıyla çalışmalar yapılarak ve eğitim, bilim, profesyonellik gibi kavramlarla destek sağlanarak mesleğin ilerlemesi sağlanmıştır. Hemşirelik, değerleri ve etik ilkeleri olan bir meslek haline gelmiştir. Yaşadığımız dünya savaş, doğal afet, iklim değişikliği, salgın hastalık gibi birçok faktör nedeniyle sürekli bir değişim içerisinde. Hemşireliğin, sürekli değişen dünyada hem varoluşunu sürdürebilmesi hem de geliştirebilmesi için değerlerini koruması ve yeni nesil hemşirelere bu değerleri taşıyabilmesi önemlidir. Hemşirelerin mesleki ve profesyonel değerleri açısından eğitimin ve çalışma koşullarının önemli olduğu değerlendirilmiştir. Bu nedenle hem öğrenci hem de mezun hemşirelere değerler eğitiminin belirli aralıklarla tekrarlanarak ve etkin eğitim metotları ile verilmesi gereklidir. Aynı zamanda çalışma planlarının kişinin sosyal hayatı engellemeyecek şekilde yapılması, bilimsel faaliyetlere katılım sağlama, motivasyon unsurlarını kullanma gibi tükenmişliği önleyecek stratejilerin geliştirilmesi mesleki değerlerin korunması ve meslekten ayrılmaların önlenmesi açısından önemli bulunmuştur.

## KAYNAKLAR

1. Bozdoğan ŞN, Demirci B, Ceylan E, Vardar İnkaya B. Evaluation of nursing image perceptions among students in faculty of health sciences. *J Acad Res Nurs*. 2021;7(1):10–8.
2. Çamlıca T, Kartal H. Historical development of nursing education. *Turk Klin J Med Ethics-Law Hist*. 2021;29(1):142–7.
3. Köse KN, Su S. Hemşirelik öğrencilerinin mesleki değerleri ile hemşirelik tanılarını algılamaları arasındaki ilişki. *J Gen Health Sci JGEHES Necmettin Erbakan Univ*. 2021 Apr 25;3(1):20–8.
4. Uslu Ö, Kızılkaya M. Determining the professional values of nurses. *Sağlık ve Hemşire Yönetimi Derg* [Internet]. 2021 [cited 2022 Jul 28]; Available from: <https://shydergisi.org/jvi.aspx?pdire=shyd&plng=tur&un=SHYD-28290>
5. Shersingh M. Florence Nightingale: The pioneer leader of nursing profession. *NOLEGEIN Journal of Leadership & Strategic Management*. 2022;5(1).
6. Adıgüzel O, Tanrıverdi H, Özkan D. Mesleki profesyonellik ve bir meslek mensupları olarak hemşireler örneği. *Yönetim Bilimleri Dergisi*. 2011;9(2):239–59.
7. Bilge A, Engin E. Kişilerarası ilişkiler kuramı temelli çözüm odaklı terapinin etkinliği: geriye dönük bir inceleme. *Anadolu Psikiyatri Dergisi*. 2016;17(4):261–9.
8. Pehlivan T, Güner. Teorilerin psikiyatri hemşireliğinde kullanımı-II. *Psikiyatri Hemşireliği Dergisi*. 2016;7(2):100–4.
9. Şahin N, Bayram G, Avcı D. Kültürlere duyarlı yaklaşım: transkültürel hemşirelik. *Hemşirelikte Eğitim ve Araştırma Dergisi*. 2009;6(1):2–7.
10. Cinper Ç. Diyaliz hemşireleri işlevlerinin profesyonel yaklaşım yönünden değerlendirilmesi [yüksek lisans tezi]. [Sağlık Bilimleri Enstitüsü]: İstanbul Bilim Üniversitesi; 2011.
11. Kuçuradi İ. İnsan ve Değerleri [Internet]. Türkiye Felsefe Kurumu; 2013. Available from: <https://docplayer.biz.tr/52072292-loanna-kucuradi-baski-insan-ve-degerleri-turkiye-felsefe-kurumu.html>
12. Schmidt BJ, McArthur EC. Professional nursing values: A concept analysis. *Nurs Forum (Auckl)*. 2018 Jan;53(1):69–75.
13. Babadağ K. Hemşirelik ve Değerler [Internet]. 1st ed. Alter Yayıncılık; 2010. 31–55 p. Available from: [https://books.google.com.tr/books?id=DFDREAuEHw4C&pg=PA2&pg=PA2&dq=Lynaugh+\(1996\)+NURS%C4%B0NG+history&source=bl&ots=IjIGGppllb&sig=ACfU3U14ep1bapq3\\_I9Axyz4WNQ9P5ITA&hl=tr&sa=X&ved=2ahUKEwjNtOK5\\_4fxAhURG-wKHR-iA60Q6AEwEnoECA4QAw#v=onepage&q=Lynaugh%20\(1996\)%20NURS%C4%B0NG%20history&f=false](https://books.google.com.tr/books?id=DFDREAuEHw4C&pg=PA2&pg=PA2&dq=Lynaugh+(1996)+NURS%C4%B0NG+history&source=bl&ots=IjIGGppllb&sig=ACfU3U14ep1bapq3_I9Axyz4WNQ9P5ITA&hl=tr&sa=X&ved=2ahUKEwjNtOK5_4fxAhURG-wKHR-iA60Q6AEwEnoECA4QAw#v=onepage&q=Lynaugh%20(1996)%20NURS%C4%B0NG%20history&f=false)
14. Daşbilek F. Hemşirelerin kişisel değerleri ile etik duyarlılıklarının bazı değişkenler açısından incelenmesi (yüksek Lisans Tezi). [Erzurum,Türkiye]: Atatürk Üniversitesi; 2016.
15. Kaya A, Kantek F. Yönetici hemşirelerin profesyonel değerler algısı ve etkileyen faktörler. *Journal of Health and Nursing Management*. 2016;3(1):8.

16. Tuna R, Kahraman B. Bir devlet hastanesindeki ameliyathane hemşirelerinin profesyonel değerleri ve etkileyen faktörler. *Yoğun Bakım Hemşireliği Dergisi*. 2021;25(2):60–7.
17. Karadağlı F. Hemşirelik öğrencilerinin profesyonel değer algıları ve etkileyen faktörler. *Mersin Üniversitesi Sağlık Bilimleri Dergisi*. 2016;9(2):81–91.
18. Demir S, Yıldırım N. Psikiyatri hemşirelerinin profesyonel davranışlarının belirlenmesi. *Psikiyatri Hemşireliği Dergisi*. 2014;5(1):25–32.
19. Ekiz Erim S, Çevirme A. Hemşirelikte kişisel ve profesyonel değerlerin farkındalığı önemli mi? *Anadolu Hemşirelik ve Sağlık Bilimleri Dergisi*. 2018;21(4):279–84.
20. Can Ş, Acaroğlu R. Hemşirelerin mesleki değerlerinin bireyselleştirilmiş bakım algıları ile ilişkisi. *İstanbul Üniversitesi Florence Nightingale Hemşirelik Dergisi*. 2015;23(1):32–40.
21. Poorchangizi B, Borhani F, Abbaszadeh A, Mirzaee M, Farokhzadian J. Professional values of nurses and nursing students: a comparative study. *BMC Med Educ*. 2019 dec;19(1):438.
22. Rassin M. Nurses' professional and personal values. *Nurs Ethics*. 2008 Sep;15(5):614–30.
23. DüNDAR T, Özsoy S, Toptaş B, Aksu H. Hemşirelikte mesleki değerler ve etkileyen faktörler. *Ege Üniversitesi Hemşire Fakültesi Derg*. 2019 Apr 30;35(1):11–9.
24. Görüş S, Kılıç Z, Ceyhan Ö, Şentürk A. nurses' professional values and affecting factors. *J Psychiatr Nurs*. 2014;5(3):137–42.
25. Jiménez-López FR, Roales-Nieto JG, Seco GV, Preciado J. Values in nursing students and professionals: an exploratory comparative study. *Nurs Ethics*. 2016 Feb;23(1):79–91.
26. Day L, Ziehm SR, Jessup MA, Amedro P, Dawson-Rose C, Derouin A, et al. The power of nursing: an innovative course in values clarification and self-discovery. *J Prof Nurs*. 2017 Jul;33(4):267–70.
27. Çelik S, Ünal Ü, Saruhan S. Cerrahi kliniklerde çalışan hemşirelerin mesleki profesyonelliklerinin değerlendirilmesi. *İstanbul Üniversitesi Florence Nightingale Hemşirelik Dergisi*. 2012;2(3):193–9.
28. Dikmen Y, Yönder M, Yorgun S, Usta Y, Umur S, Aytekin A. Hemşirelerin profesyonel tutumları ile bunu etkileyen faktörlerin incelenmesi. *Anadolu Hemşirelik ve Sağlık Bilimleri Dergisi*. 2014;17(3):158–64.
29. Yayla A, Özlü Z, Gümüş K, Sevinç G, Khaghani E. İki farklı kültürdeki hemşirelerin profesyonel değerlerinin incelenmesi: farklı iki ülke örneği. *Uluslararası Hakemli Hemşirelik Araştırmaları Dergisi*. 2015;(5):19–33.
30. Aiken LH. Hospital nurse staffing and patient mortality, nurse burnout, and job dissatisfaction. *JAMA*. 2002 Oct 23;288(16):1987.
31. Marques-Pinto A, Jesus ÉH, Mendes AMOC, Fronteira I, Roberto MS. Nurses' intention to leave the organization: a mediation study of professional burnout and engagement. *Span J Psychol*. 2018;21:E32.
32. Xie J, Li J, Wang S, Li L, Wang K, Duan Y, et al. Job burnout and its influencing factors among newly graduated nurses: A cross-sectional study. *J Clin Nurs*. 2021 Feb;30(3–4):508–17.
33. Cheng F, Meng A feng, Jin T. Correlation between burnout and professional value in Chinese oncology nurses: A questionnaire survey. *Int J Nurs Sci*. 2015 Jun;2(2):153–7.